

COVER  POOLS®

AUTOMATIC POOL & SPA COVERS



Save-T® 3 System



COVER-POOLS LETS YOU FOCUS ON FUN

If you already have a pool, or if you're planning to build one, a Cover-Pools automatic pool cover is the best way to safeguard loved ones, save money on heating costs and chemicals and protect your investment.

Find out for yourself what delighted pool owners all over the world have already discovered – our automatic pool covers are the finest, safest, and easiest-to-use pool cover you can buy. So, kick back, relax, and enjoy all the benefits of pool ownership. Cover-Pools has you covered.

**WITH A POOL COVER,
YOU GET PEACE OF MIND**

With a Cover-Pools cover you get peace of mind with the simple turn of a key. In under a minute your pool is easily covered or uncovered. Your Cover-Pools cover acts as a “horizontal fence” for your pool, preventing access by children, pets, and uninvited visitors. And while there’s no substitute for proper supervision, your pool can be protected even when you’re not around. It’s a safety barrier that no pool should be without.

Designed for Safety

Cover-Pools covers are tested and listed by Underwriters Laboratories (UL), an independent Nationally Recognized Testing Laboratory (NRTL), as being in conformance with the applicable requirements of performance & safety standards such as ASTM F1346-91, published by the American Society of Testing and Materials (ASTM).

Follow all safety and warning notices found in the owners manual.

**PROTECT YOUR POOL
AND YOUR LOVED ONES.**



WARNING:
Do not walk or stand on cover
except in an emergency.





A Cover-Pools cover extends your swimming season by reducing heat loss.

A POOL COVER SAVES UP TO 70% ON OPERATING COSTS

The U.S. Department of Energy states* that a pool cover is “the single most effective means of reducing pool heating costs.”

Saving you up to 70% on pool operating costs, a pool cover also helps prevent the evaporation of both precious water and expensive chemicals. It even acts as a passive solar heater by capturing the sun’s radiant heat extending your swimming season.

At the same time, a pool cover keeps dirt and debris out of the pool, reducing cleaning, maintenance costs and overall wear on pool equipment. Cover-Pools covers have proven to be one of the best ways of reducing pool expenses all year long.





For indoor pools, a cover provides the added benefit of eliminating the need for expensive dehumidification systems.

SAVINGS AND CONVENIENCE



Saves energy, adds heat.

A Cover-Pools cover dramatically reduces heating costs and extends your swimming season by acting as a giant solar collector.



Saves water and chemicals.

By reducing evaporation, your Cover-Pools cover cuts water loss and reduces the use of chemicals.



Saves cleaning.

Keep dirt, leaves, and debris out by simply keeping your pool covered.



Saves pool equipment, extends pool life.

With a covered pool, you keep the heat in and the dirt and debris out. Heaters and other pool equipment work less and last longer.



Saves money.

By saving heat, chemicals, cleaning, and extending equipment life, your Cover-Pools cover quickly pays for itself. You can save up to 70% on operating costs, which is a great return on your investment.



Vanishing-edge pool

ANY POOL, ANY SHAPE – WE HAVE YOU COVERED

New Construction

At Cover-Pools, we love a good challenge. So go ahead, bring us your freeform pools, your pool / spa combos, L shapes, kidney shapes, and anything else you can dream up. If you can build it, we can cover it.

Every pool makes its own unique statement, and Cover-Pools believes design should never be an obstacle to the benefits of a strong and dependable pool cover.

UNIQUE SHAPES

**WE CAN COVER YOUR POOL
NO MATTER WHAT THE SHAPE.**

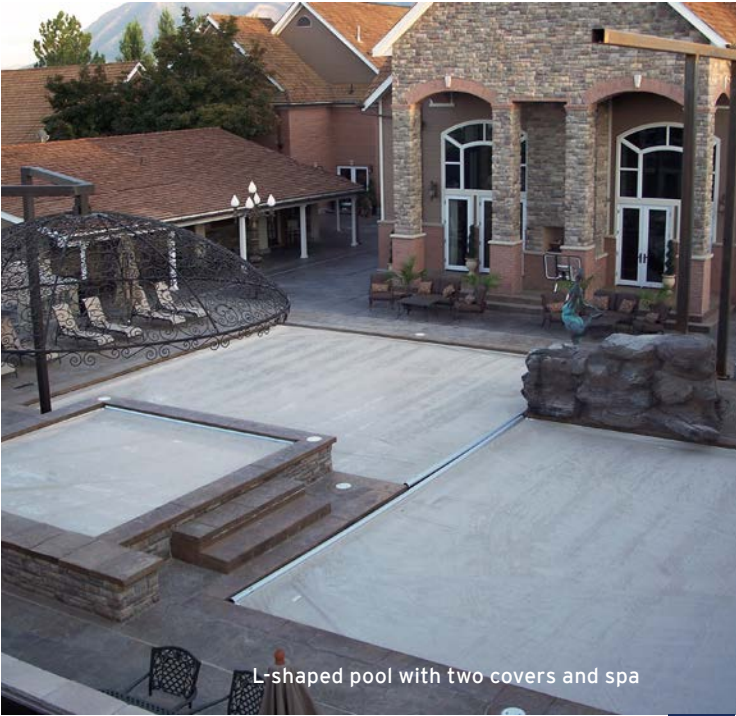
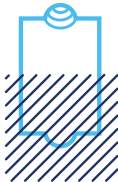

A CUSTOM POOL DESERVES A CUSTOM-DESIGNED SYSTEM



“Cover-Pools has the best system on the market. I have worked on every automatic cover out there and none compare in both quality and customer service.”

Mark Sheinman
Pennco Automatic
Pool Covers

“We depend on both the high product quality and business integrity that Cover-Pools is known for. We would not install or recommend any other cover.”

Alan and Coni Stiles
Arizona Pool Covers

CUSTOM APPLICATIONS



Pool with rock features and waterfall



Deck-on-deck pool and spa with rock features and waterfall



Perimeter overflow pool

Since 1962, we've been designing custom covers that accommodate virtually any pool shape or design. As pool design evolves and trends emerge, Cover-Pools develops new and more creative ways to cover any pool. From waterfalls and rockwork to vanishing edges and other water features – no challenge is too great.

Our staff of experts work with architects, engineers, and builders, providing them with knowledgeable input to help cover the pool of your dreams.

LET OUR TRACKS GUIDE YOU



UNDERMOUNT TRACK SYSTEMS

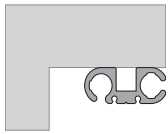

Underside design allows a variety of deck profiles.

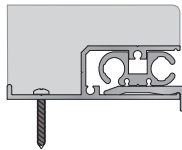

Low-profile Track Channel

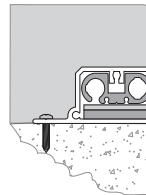

Deck-on-deck with Standard Track Channel

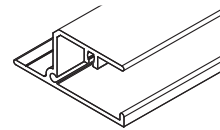

Corr-Resist™ Non-Metallic Track Channel

Underside™ Track system

Underside track is a perfect way to fully integrate the cover into the pool and deck. With an Underside track installation, the tracks are concealed beneath the deck. It's the ultimate in smooth, worry-free operation.

Underside Track and Track Channel

For freeform pools with Underside track, the channel makes it easy to construct deck-on-deck applications around any vinyl, fiberglass, or concrete pool.

Corr-Resist™ Non-Metallic Track Channel

Our industry-exclusive non-corrosive track channel is built to withstand the harshest pool environments. The channel is composed of rigid polymer material that is perfect for saltwater pools.

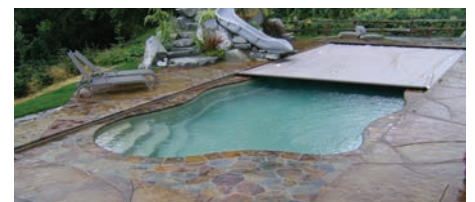
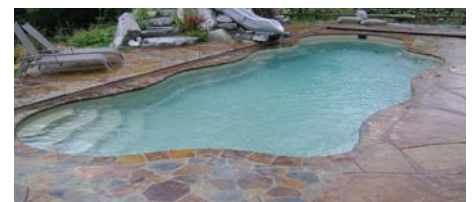

TRACK, CHANNEL AND COPING



V-PAK™ KIT

Cover Kit for Vinyl-Liner Pools

The V-Pak kit is a complete, easy-to-install cover kit for vinyl-liner pools, which includes:

- Cover unit and fabric
- Flush-mount Lid (other lid forms available upon request)
- Coping for three sides (see examples to the right)
- Stainless steel lid bracket
- Deluxe Ultimate Polymer Box (UPB)
- Beam Cover with vinyl retainer provides protection for the cover fabric
- Square, 45°, 6" or 24" radius corners
- Available in white or gray
- Four standard pool sizes—14' x 28', 16' x 32', 18' x 36', 20' x 40'

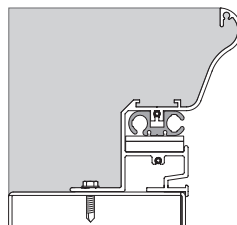

Vinyl-liner coping Standard

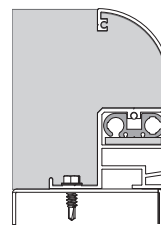

Vinyl-liner coping Bullnose

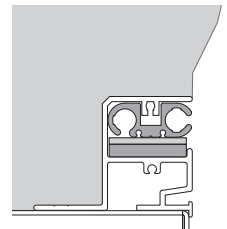

Track channel with vinyl retainer

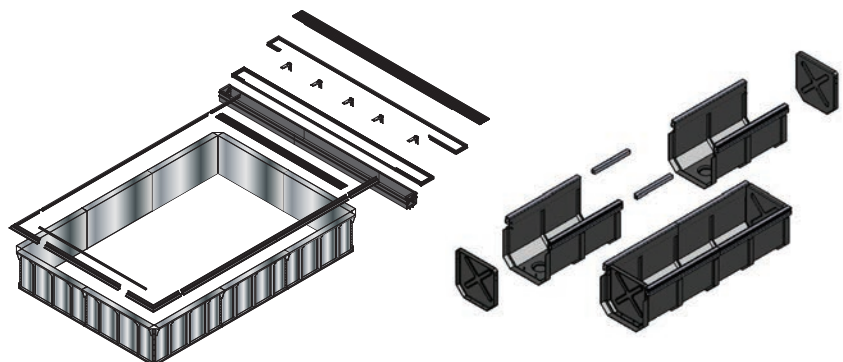

Complete V-Pak Kit

Ultimate Polymer Box



Deck mount system with gliders and deck mounted mechanism bench

DECK MOUNT TRACK SYSTEMS

Universal Track System

Universal track can cover existing pools of virtually any shape or construction. Just give us enough deck room to run the low-profile tracks parallel to one another on opposite sides of the pool and we can put a cover on almost any pool.

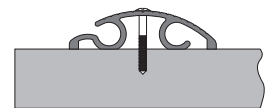

Standard Universal track

SnapTop™ Track System

SnapTop track is a two-piece track system that conceals the screws from view and creates a smooth, streamlined track surface.

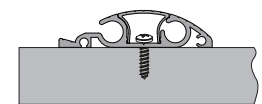

SnapTop track

Flush Track System

Flush track is a deck-mounted track that is installed flush with the deck. The channel comes with a reduced width, provides debris protection, allows for smoother cover operation and less fabric-wear, and a built-in rope diverter. The snap-in-place stand provides easy height adjustments during installation.

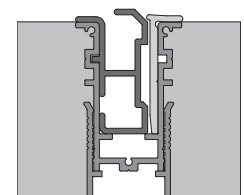

Flush track

Universal tracks mount securely to the pool deck and can be painted to coordinate with the deck.



Undertrack system with square leading edge

LEADING EDGE AND GLIDER

Round Leading Edge

The leading edge is designed to guide your pool cover across the water ensuring smooth operation and a strong, flush seal at the far-end pool wall. Each Cover-Pools pool cover comes standard with a round leading edge.



Round Leading Edge
(with optional bumper)

Square Leading Edge*

The optional square leading edge adds rigidity over the round leading edge and a modern finish to your pool cover. The square shape reduces deflection making it easier to hide the leading edge and creates a better seal. It may also be wrapped in matching fabric for a more seamless look.



Square Leading Edge
(wrapped with optional fabric)

*Only available for pools up to 25' wide and applications using adjustable gliders.

Low Profile Rectangular Leading Edge**

Our smallest leading edge at 1 1/2" x 3 1/2" for a sleek modern finish that holds fabric with a built-in channel (can also be used with a fabric pocket). Our low profile rectangular design resists deflection in both vertical and horizontal directions while providing 18% less deflection than competing leading edges of similar form.



Low Profile Rectangular Edge

**Only available for pools up to 16' wide.

Adjustable Glider and Dowel

The adjustable glider and dowel combination can incrementally adjust the leading edge height 3" above or below the track. The dowel is standard with most undermount track systems.



Glider & Dowel



LIDS AND BENCHES

Deck-Mounted Mechanism

When mounting a mechanism to the deck an Everlast Bench or Everlast Ends provide convenient and durable protection.

You can also create your own bench design with our bench frames and materials supplied locally by your dealer or an independent contractor.

Four Everlast polymer colors are available. Please see polymer samples when making color choice. Actual colors may vary.



Everlast Bench



Everlast Ends



White



Tan



Gray



Terra Cotta

Recessed Mechanism

The mechanism can be discretely housed in a box below the deck surface. This option works best if chosen before construction. However, if there is room to cut into the deck of an existing pool, the mechanism can still be recessed. Cover-Pools offers many lid options for covering the mechanism.



Typical position of leading edge when cover is fully retracted.

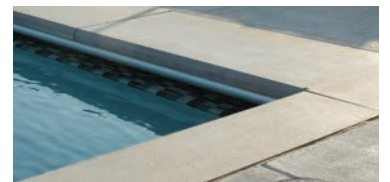

Extended Vanishing Lid™ allows the leading edge of the retracted cover to be hidden.

Easy Roller™ System

The Easy Roller system reduces cover friction between the cover and the beam edge, providing smoother cover operation and less wear on the fabric, while maintaining cover performance.



LIDS AND BENCHES



Standard Lid

Our standard lid for both Universal track and Underside™ track systems offers an economical way to conceal and protect the mechanism. Not intended to be walked on.



Flush-Mount Lid

Our flush mount lid is a walk-on lid that completely covers a recessed pool cover mechanism while remaining even with the surface of the deck.



Flat Bezel™ Lid

Designed for Undermount track systems, the flat Bezel lid provides step-on strength with a more streamlined appearance and beveled edges.



Tilted Bezel Lid / Stepped Bezel Lid

The tilted or stepped Bezel lid (shown) for Universal and SnapTop track systems provides step-on strength with a narrow tilt or low-profile rise to accommodate the track. It also has beveled edges.

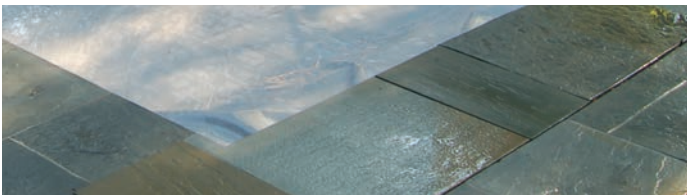

Vanishing Lid™ System

The Vanishing Lid System provides the most integrated look for concealing the mechanism. Your coordinating deck material hides the mechanism housing and blends into the rest of the deck.



Extended Vanishing Lid

The Extended Vanishing Lid system allows the cover to retract completely under the lid. This requires the lid system to be 18" to 24" wide.



Vanishing Lid™ Foam Forming System

The NEW Vanishing Lid™ (V-Lid) Foam Forming System provides an easy, cost-effective, disposable solution for poured concrete lids to an automatic pool cover mechanism.

All aluminum lids can be powder coated to coordinate with your deck. Choose from a selection of standard colors or special-order colors. Please see Powder-Coated Extrusion samples when making color choice. Actual colors may vary.

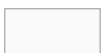

Sky White

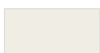

Autumn White

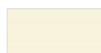

Almond



Coffee Tan



Camel

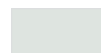

Gray 240



ASA-61 P Gray



Statuary Bronze

SAVE-T® 3 MOTOR AND MECHANISM

Meet the brawn behind the beauty. Cover-Pools' exclusive mechanism is built especially for the pool environment. High-grade stainless steel hardware and anodized-aluminum components including the castings, extrusions, frame and brackets are specifically designed for today's mineral sanitizers to prevent corrosion and contribute to smooth operation and overall longevity of the system.

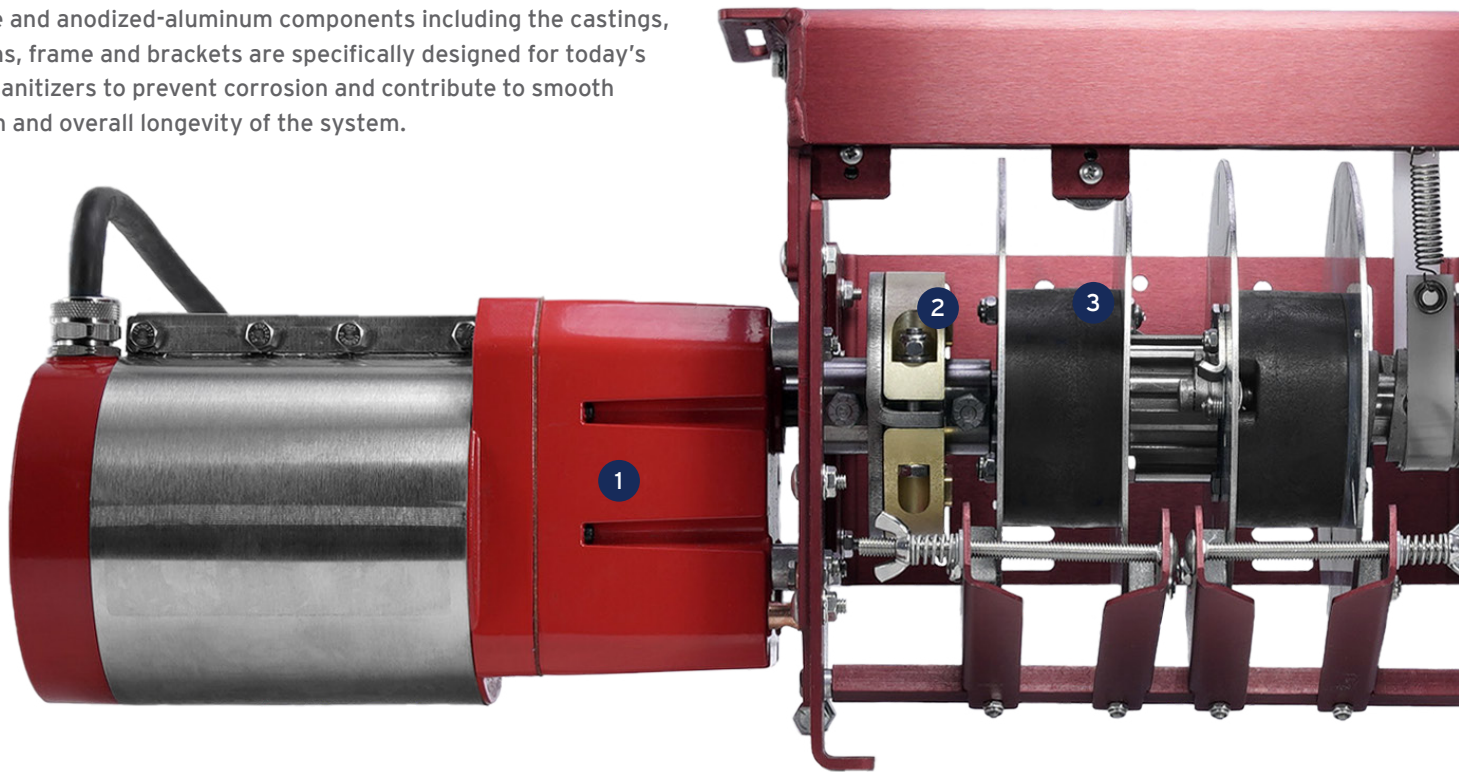

- 1 3/4 HP Water Resistant Motor
- 2 Slip Clutch*
- 3 Corr-Resist™ Rope Reel System
- 4 Stainless Steel and Aluminum Mechanism
- 5 Positive Shift System
- 6 Corr-Resist Hybrid End Casting
- 7 Marine-Grade Anodized Roller Drum

Ultimate™ Rope Strength

Cover-Pools' exclusive Ultimate Rope is the strongest and most inelastic rope in the industry – ensuring reliable operation of the cover. Averaging over 100,000 cycles, nearly double that of other ropes, the low-stretch materials of this rope option reduces misalignment problems caused by stretching over time.



Simple Cover Alignment

Cover-Pools' exclusive EZ-Lock Rope Reel System ensures simple cover alignment. This hybrid rope reel with stainless steel side plates is designed for quiet operation and utilizes exclusive Corr-Resist technology for superior corrosion prevention. (Learn more about Corr-Resist on pg. 20)

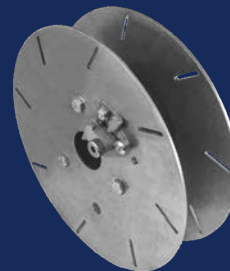

MOTOR, MECHANISM, CONTROLS, AND SWITCHES



Key or Toggle Switch

Turn the key or toggle the switch to cover or uncover your pool. To maintain a secure system, simply remove the key or lock the toggle switch cover after you've covered the pool.



CoverLink™ Digital Control

The code-accessed digital control system allows you to program up to four codes to create convenient and secure access to the system. Wireless version also available.

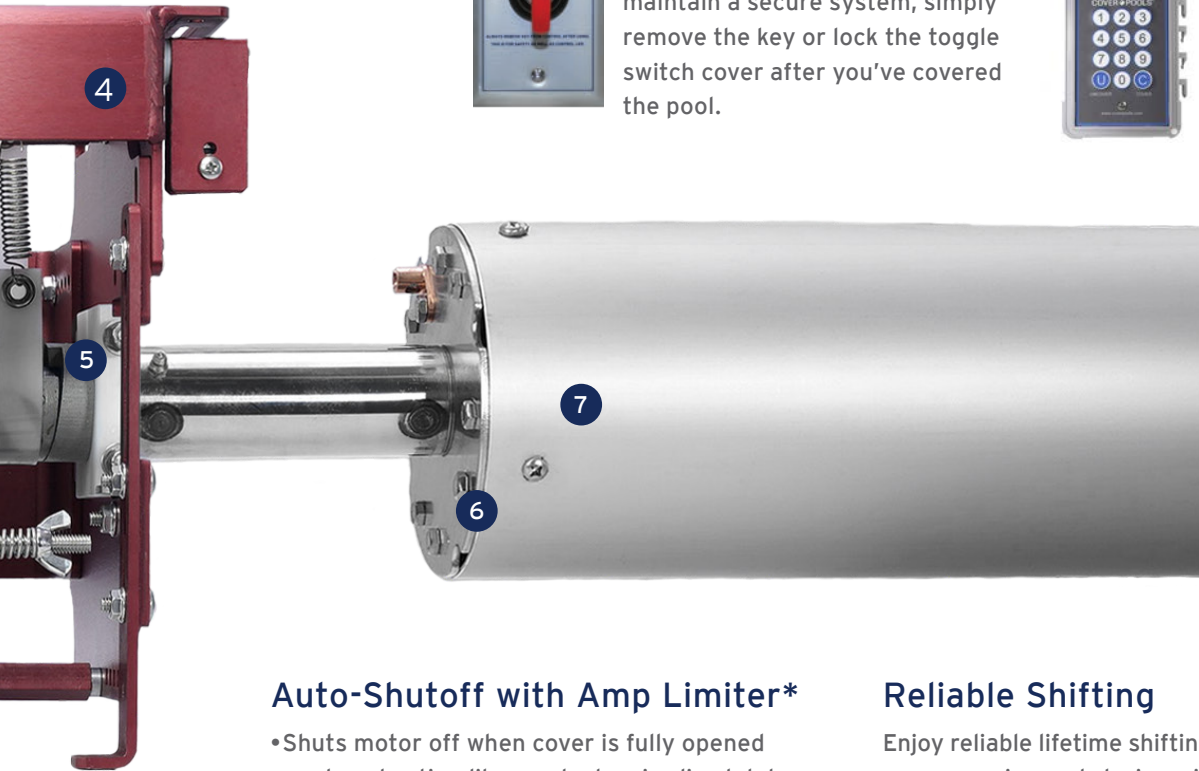

Auto-Shutoff with Amp Limiter*

- Shuts motor off when cover is fully opened or closed acting like an electronic slip clutch
- LED diagnostic indicators
- Enables accessory board with AquaLink automation integration (see pg. 19)

*Only available with electric system. Slip Clutch not required with this option.

Reliable Shifting

Enjoy reliable lifetime shifting between cover opening and closing with Cover-Pools' exclusive Positive-Shift System. This system provides complete gear engagement with each use featuring hard-cast stainless steel gears a 3/8" solid stainless steel drive dowel for strength and durability.



Hydraulic System Option

For special site conditions or for those who prefer hydraulics, the Cover-Pools powerful hydraulic system provides more compact components and increased space efficiency. Its sensitive pressure-release system allows for adjustable power and a built-in automatic shutoff. Lower operating pressure provides maximum safety.



QUAD-CORE™ FABRIC

Quad-Core laminated fabric is exclusive to Cover-Pools. Made for pool and spa covers, Quad-Core is reinforced with a strong polyester mesh for strength and tear resistance, this high-performance vinyl-resin formula provides maximum durability in the swimming pool environment.

Quad-Core vinyl laminated fabric is also available in 35 special order colors to coordinate with any pool. Please see fabric samples when making color choice; Actual colors may vary.

Quad-Core Fabric



PRO-COAT™ FABRIC

Pro-Coat coated fabric uses an enhanced coated formula for the pool and spa environment that provides long-lasting durability with UV protection, advanced tensile strength and exceptional resistance to abrasions, tears and chemical deterioration.

Pro-Coat Fabric



Strength meets or exceeds the ASTM F1346-91 minimum standard of 485 lbs per 3' radius.



FABRIC, CONTROL SYSTEMS, AND ACCESSORIES

The Intelligent Pool Cover

With Jandy® AquaLink® integration, Cover-Pools pool cover owners can control other pool features based on the position of their cover. When the cover is closed, AquaLink will deactivate any water features, limit chlorine output, and reduce pump runtime saving up to 50% on energy and chemicals.

By including a Cover-Pools Interface Board with their purchase of a Jandy AquaLink control system, pool owners gain the following functionality:

- One Touch™ controller shows whether the pool cover is open, closed, or partially open
- iAquaLink® app* shows whether the pool cover is open, closed, or partially open
- Salt chlorine production levels automatically adjust when the cover is opened or closed
- Water features, booster pump cleaners and pool lights will automatically shut off when the cover is closed
- Pump runtime automatically decreases when the cover is closed

This increased functionality will automatically:

- Save energy and operating costs
- Lengthen the life of the salt cell
- Avoid over chlorination of the pool
- Save water, protect the cover, and give pool owners extra peace of mind

* For safety, the app cannot operate the cover as the control must be mounted in view of the pool.

AquaLink®

Auto-Shutoff Control with Optional Accessory Board

The auto-shutoff control stops the cover automatically when it is fully opened or closed. The accessory board controls operation of water features, fiber optics, alarms, etc., in conjunction with opening and closing the cover.

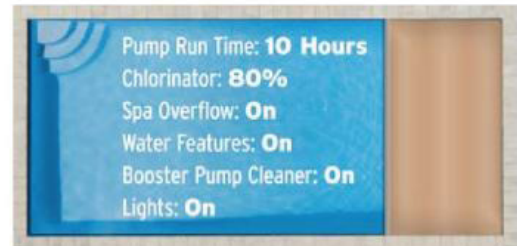

Pool Cover Open

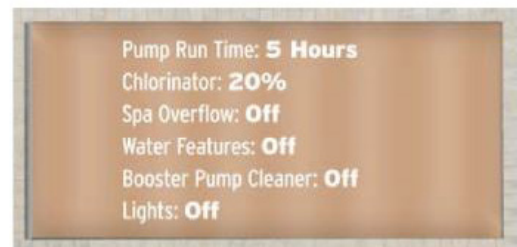

Pool Cover Closed

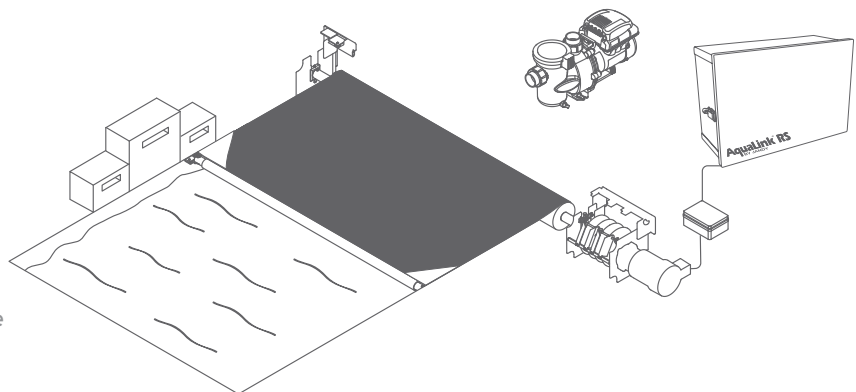

Automatic Water Pump

Cover-Pools systems use an automatic pump (as required by ASTM safety standards) to conveniently remove standing water that may accumulate on top of the cover as a result of rain, sprinklers or cleaning. The pump automatically turns itself on when water is present and shuts off once the water has been removed.

DESIGNED TO PERFORM IN ALL POOLS – SALTWATER POOLS INCLUDED

Corr-Resist™

The swimming pool environment can be harsh on a pool's components. Salt, chlorine and other chemical usage often causes galvanic corrosion of metal parts. Our exclusive Corr-Resist technology shields against this by breaking the corrosive path including avoiding dissimilar metal contact as well as using marine-grade materials.

Mechanism Brackets

- All stainless steel drive components
- Marine-grade anodized aluminum components

Corr-Resist End Hub

- End hub with stainless steel and durable polymer parts prevent corrosion
- High-density polymer tube mounts break the corrosive path between dissimilar metals

Corr-Resist Track Channel*

- Durable, non-metallic track channel composed of UV-resistant rigid polymer material
- Eliminates all salt corrosion to protect one of the most fundamental parts of the cover system

*Available only in Underside track channel.

Marine-Grade Anodized Aluminum Tube

- Anodized tube creates an armored shield against corrosion
- Coated tube end upgrade – additional polyurethane coating that encases the tube ends with a protective shield



Galvanic corrosion occurs when different metals touch

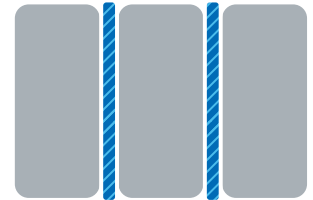

Corr-Resist technology shields metals from corrosion

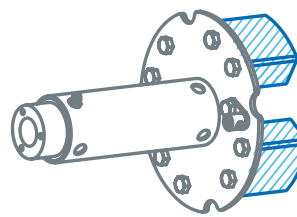

Stainless Steel Part
Resists corrosive environment

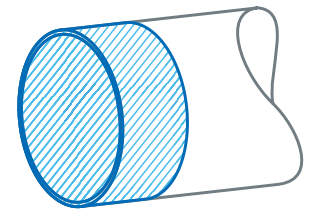

High-Density Polymer Tube Mounts
Isolates the end hub from the tube breaking the corrosive path

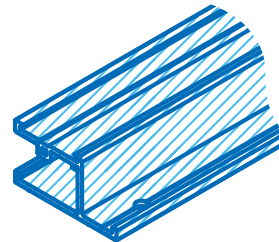

Non-Metallic Track Channel
Eliminates salt corrosion along channel with rigid polymers

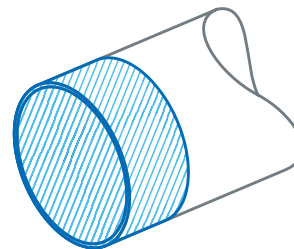

Polyurethane Tube End Coating Upgrade
Encases the tube end with an additional protective shield

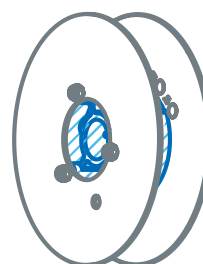

Stainless Steel Reel Plates with Glass-Reinforced Polymer Center Hub
Isolates and breaks the corrosive path

CORR-RESIST, AUTOSAVE, AND WARRANTIES

AUTOSAVE™ SPA COVER

The Autosave spa and swim spa cover offers the same safety and energy-saving benefits as a full-size automatic pool cover with a more compact mechanical system. Designed for space-restricted installations, the Autosave cover can be used on new and existing spas, swim spas, and small pools.

- The compact motor and mechanism reduce the space required for an automatic cover system
- Can be used for in-ground and above-ground spas, swim spas, and small pools
- Convenient access and security at the touch of a button
- Fits within standard 12" coping for a truly rectangular raised spa
- Smaller width Everlast™ bench available

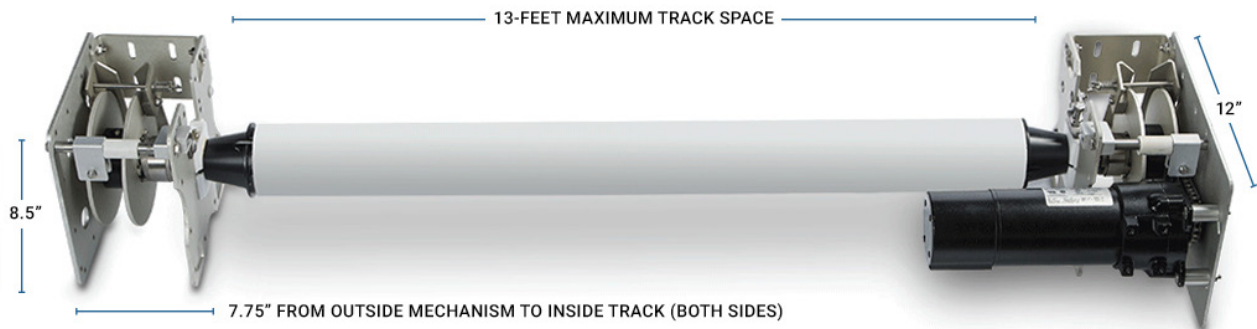

WARRANTIES

We have over 55 years of experience to support our warranties. You can stand on our reputation.

- **Lifetime Limited Warranty:** Slip clutch, mechanism
- **7-Year Limited Warranty:** Fabric*, lid assembly, tracks, leading edge, and roller tube
- **3-Year Limited Warranty:** Motor, electrical, components, and cover pump

*7-year fabric warranty as follows: First two years is full warranty and 3-7 years are prorated



SIX REASONS WHY WE ARE THE WORLD'S FINEST POOL COVER COMPANY

The most experienced automatic pool cover company in the world

When our founder, Joe Lamb, invented and patented the automatic pool cover, he also launched a new industry. Since 1962, Cover-Pools has created over 125,000 safer and more energy-efficient pools around the world.

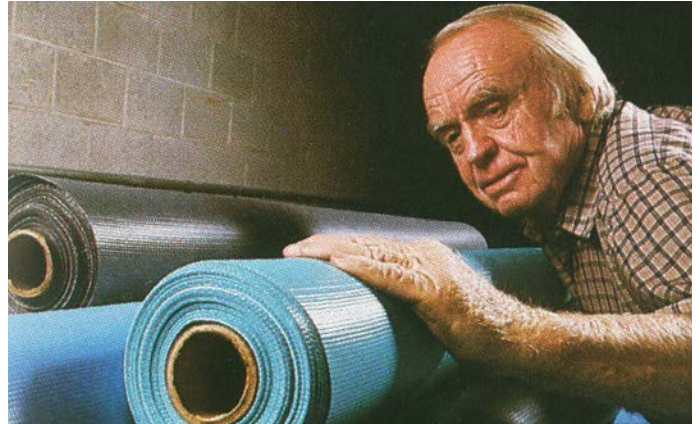

The most options for customization

Every pool is special. That's why we make your cover system to your custom specifications. Cover-Pools offers a wealth of options to blend your cover system into your outdoor living area. This means that you choose the right combination of safety, convenience, value, and beauty.



The most experienced and extensive network of dealers

With knowledgeable dealers in 50 states and over 50 countries, Cover-Pools covers the world. Cover-Pools holds annual APSP-accredited seminars for intensive dealer training and also provides in-field dealer support so you can rest assure your Cover-Pools cover is installed correctly.



All illustrations and specifications contained in this brochure are based on the latest product information available at the time of printing. Cover-Pools reserves the right to make changes at any time without notice, in colors, materials, equipment, specifications, and models.

Cover-Pools systems and parts are available through independent dealers/distributors worldwide. No dealer/distributor is an employee, agent, or representative of Cover-Pools Incorporated.

The most time-proven warranties in the industry

At Cover-Pools, we believe that the best warranties are backed by the most reliable companies. We have over 55 years of experience to support our warranties. You can stand on our reputation.



The most responsive customer-service team in the industry

Our customers constantly tell us that it's the people of Cover-Pools that make their experience so wonderful. When you call Cover-Pools, you reach a live person to provide you with knowledgeable solutions. Every employee at Cover-Pools contributes to customer service – from the production staff to the president – you know you're in capable hands.



The most innovative engineering team

To our design team, it's the little things that make Cover-Pools systems so reliable. Always on the leading edge of innovation, our engineers use the latest technology to ensure you receive The World's Finest Pool Cover.



Cover-Pools®, Save-T® and Step-Saver® are registered trademarks and Autosave™, T4™, Bezel™Lid, Corr-Resist™, CoverLink™, Easy Roller™, Everlast™ bench, PowerWheel™, Quad-Core™ Fabric, Pro-Coat™ Fabric, QuickAttach™, Slim™ Track, SnapTop™ Track, Thermal-Cover™, Ultimate™, Underside™ Track, Vanishing Lid™, V-Pak™ are trademarks of Cover-Pools Incorporated.



CoverPools.com | 1.800.447.2838

©2021 Zodiac Pool Systems LLC. All rights reserved. ZODIAC® is a registered trademark of Zodiac International, S.A.S.U., used under license. All other trademarks are the property of their respective owners. 6937_SL

800034 Rel-019